



Gomatex SRL



@gomatexsrl

## BURLETES PARA ZARANDAS DE E.P.D.M

### *Propiedades del E.P.D.M.*

- Excelente resistencia al ozono y a las condiciones ambientales.
  - Caucho de baja densidad.
  - Muy buen aislante electrico.
  - Presenta bajos esfuerzos de tension
- Son resistentes al agua caliente y al vapor, a las soluciones acuosas de acidos inorganicos.

BURLETES ZARANDA

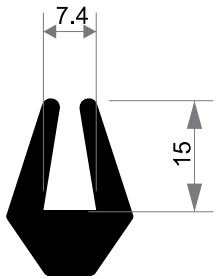

058

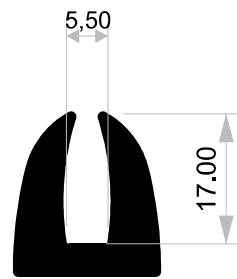

074

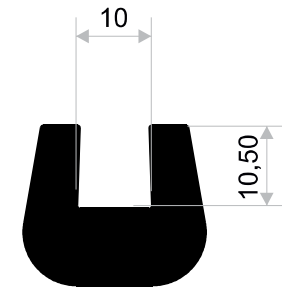

525

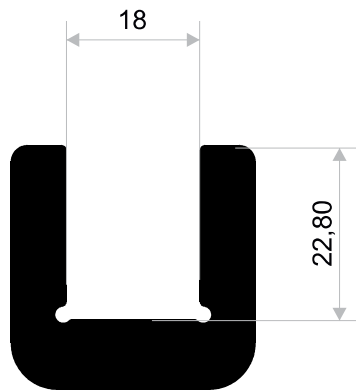

543

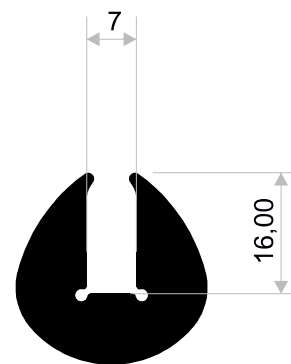

545

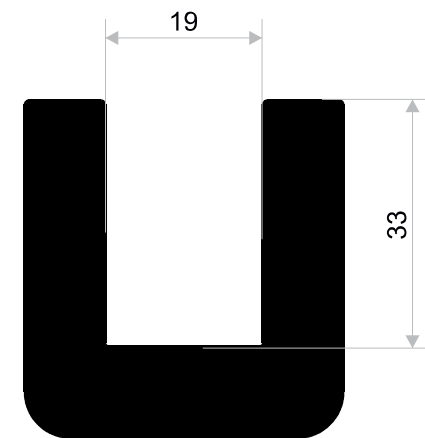

701

BURLETES ZARANDA

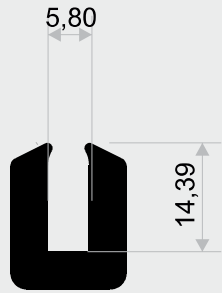

891

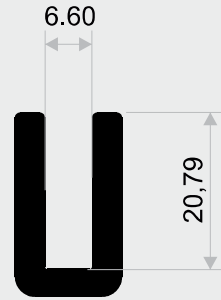

1113

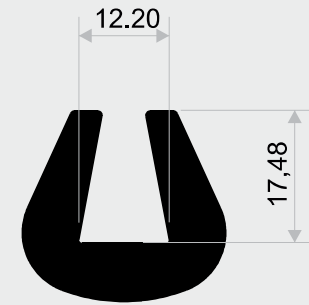

1115

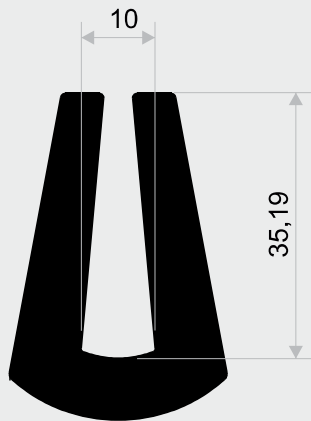

1147

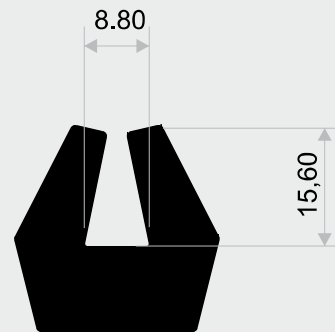

1329

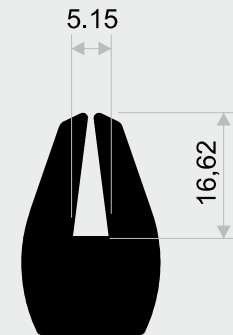

1335

BURLETES ZARANDA

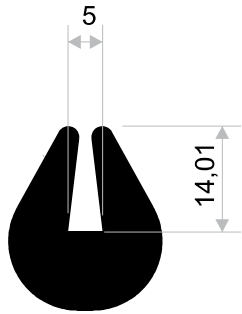

1773

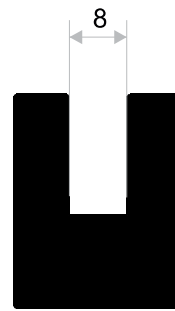

1897

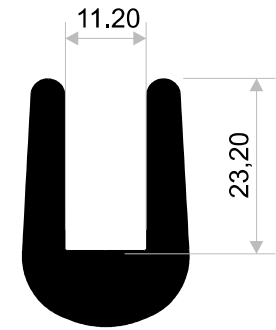

1941

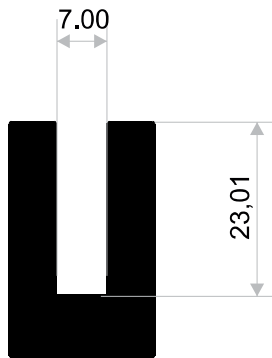

2075



2105

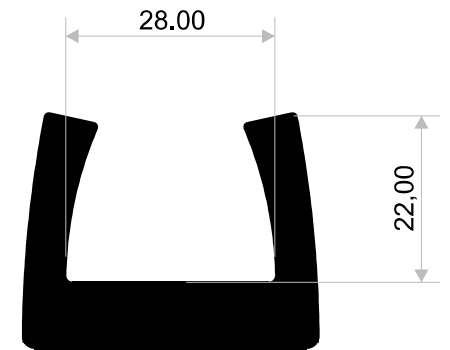

2445

BURLETES ZARANDA

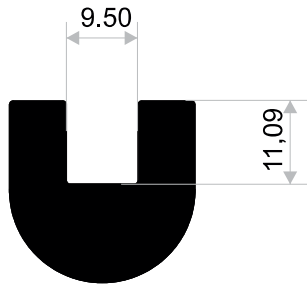

2733

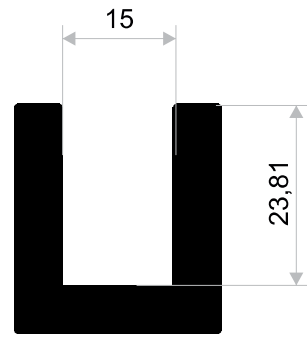

2533

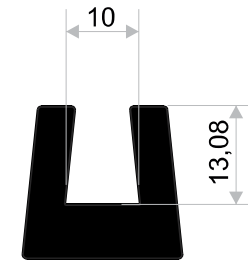

2631

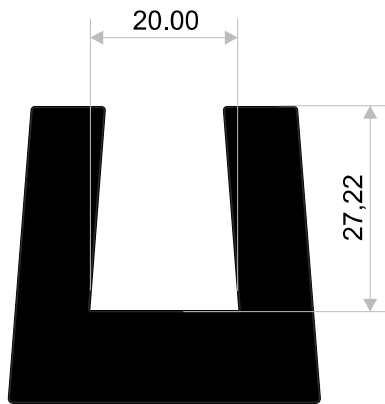

2633

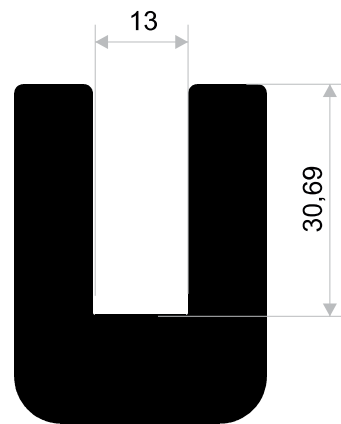

2689

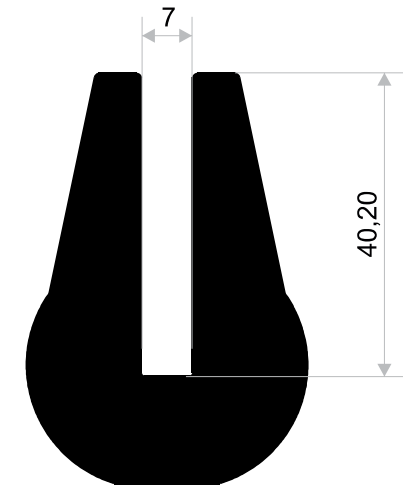

2471

BURLETES ZARANDA

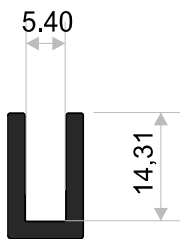

2853

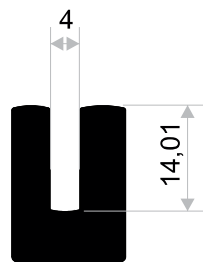

2855

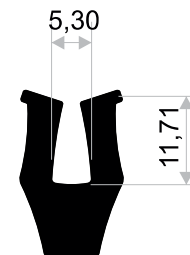

2925

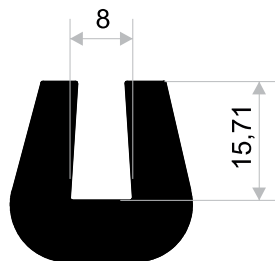

2977

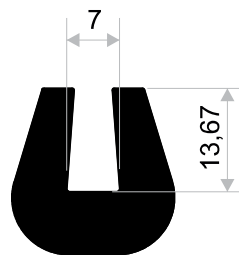

2979

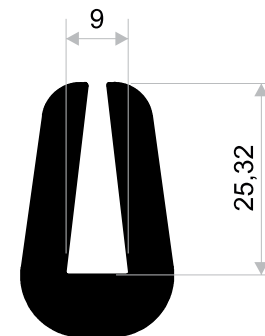

2981

BURLETES ZARANDA

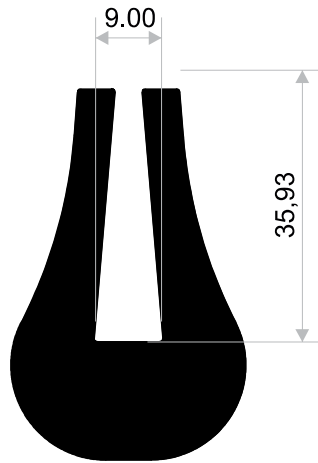

2983